



13 December 2023

FOR ATTENTION: Ms Kim Selvan

EMAIL: kim@percipient.co.za

AMENDED ARCHITECTURAL DESIGN MANUAL: ST. HELENA VIEWS, ST. HELENA BAY

Your application in the abovementioned regard refers,

Attached please find the approved amended Architectural Design Manual, approval stamp dated 13 December 2023, for your records.

Please ensure that the amended approved architectural design manual is distributed to all homeowners/ members for their records.

You are hereby informed of your and the individual HOA members right to appeal to the Appeal Authority in terms of Section 79 of the Saldanha Bay Land Use Planning By-Law. The attached appeal form must be completed and should be directed to the Municipal Manager, Saldanha Bay Municipality, Private Bag X12, Vredenburg, 7380 and received by the municipality within 21 days of notification of this decision together with the information set out in Section 80 of the By-Law.

Kindly note that no appeal right exists in terms of Section 62 of the Local Government Municipal Systems Act, No 32 of 2000.

Hope the above-mentioned meets your satisfaction and should further clarification be required, please contact the writer.

Yours faithfully

for **MUNICIPAL MANAGER**

/lg



Home Owners Association

ST HELENA VIEWS
SECURITY ESTATE
HOME OWNERS ASSOCIATION

ARCHITECTURAL DESIGN MANUAL

31 JANUARY 2023 – Revision 7 VERSION 2



TABLE OF CONTENT

1. Introduction
2. Submission of Approval
3. Building Restrictions
4. Approved Architectural Elements and Prohibited Materials
5. Definitions
6. Occupation

31 JANUARY 2023 – Revision 7 VERSION 2



1. INTRODUCTION

The Design guidelines are compiled to control the Architectural and Environmental identity of the development. The Architectural language of the St. Helena Views Development represents a contemporary interpretation of West Coast Architecture. The beauty of these buildings is characterized by an architectural simplicity and order, and humanising sense of scale and proportion. These individual buildings group well within a 'village type' urban setting to create a visually harmonious development.

The purpose of this document is to establish a set of guidelines and rules without restricting the expression of each client's individual and creative styles, but all contained to represent a harmonious and complementary style. Specific reference will be made to specific elements, finishes where applicable as well as the relationship between these.

To maintain the required standards, all dwellings must be designed by the following:

- Architect registered with the South African Institute of Architects (SACAP)
- Architectural technician or designer registered with SACAP
- Registration number must be provided on the drawings

All proposed buildings are to be approved by an Aesthetic committee consisting of the JH Serfontein, representative of the Developer and one members of the St Helena Views Security Estate HOA.

The approval or rejection of any proposed building by the Developer or his representative is final and binding by the Agreement.

1.1 Controlling Architect:

JH Serfontein
22 Montaque street
Stellenberg

Contact person: Jaco Serfontein
Contact number: 0823784132
Email: jhserf.5@gmail.com



1.2 Amendments to Architectural Guidelines:

The Developer or his representative, until the HOA takes over his role, reserves the right to make adjustments and amendments to the design guidelines, as it deems necessary from time to time, prior to the approval by the Local Authority.

No buildings, walls, fences, or other structures may be erected until they have been approved/recommended by the developer to the Local Authority and the approval of the Local Authority has been obtained.

All plans, elevations and sections are to be dimensioned and drawn to scale.

The following minimum requirements must be submitted to the Scrutiny Architect for review and consideration or approval:

- Site and all floor plans showing the following: building lines, contours, datum level, floor levels
- Proposed excavations, walls, swimming pool, and driveway
- Elevations of all buildings, structure, walls and gates
- Natural ground level as well as height restriction line
- Floor and building height levels
- Materials and colour detail of roofs, windows, doors, gutters, downpipes, walls, columns, poles, awnings
- Sections showing height of building and natural ground level
- External finishes
- **The scrutiny Architect and Developer has the right to request any additional information as per their discretion.**

Please note the above mentioned does not necessarily constitute the requirements for submission of building plans to the local Authority. All building plans submitted must be to the standards required by the Local Authority.



2. SUBMISSION FOR APPROVAL

2.1 Design Approval process:

Design Review Committee (DRC) Process

St Helena Views Security Estate

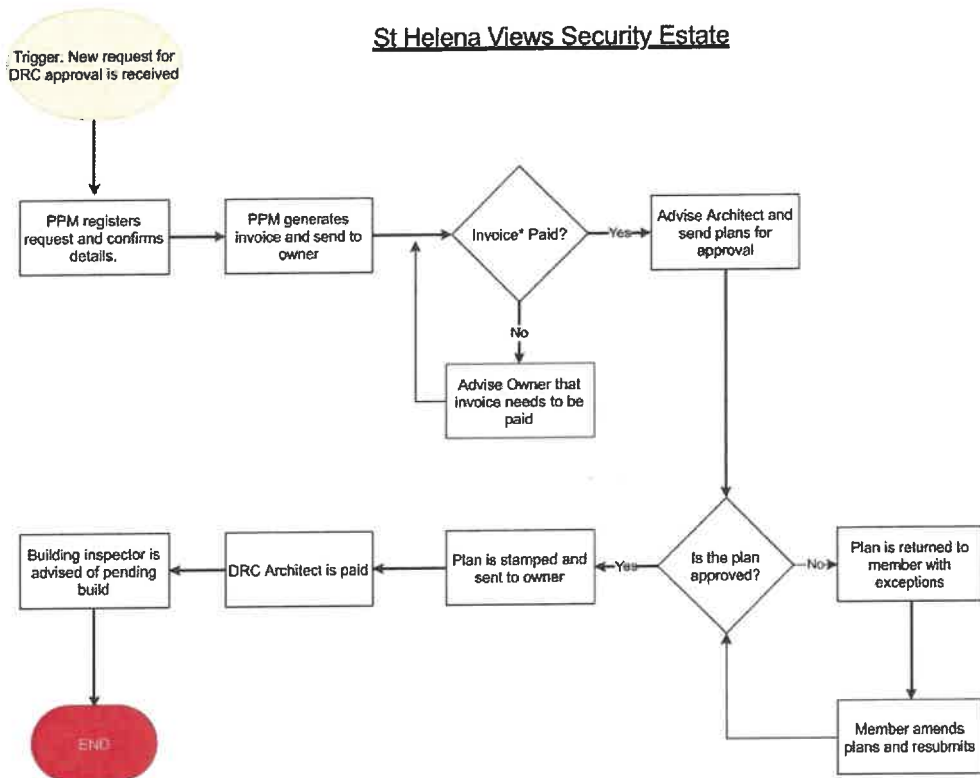

The following fees are payable before submission of plans:

Architect scrutiny fee: R 3,000.00

Increase of fees would be reviewed on an annual basis.

Once written approval has been given in form of an endorsement on the plans, you may submit to the Local Authority for approval.

It is the owner's responsibility to notify the Scrutiny Architect on commencement of construction. The scrutiny Architect would then arrange for a site visit on commencement, 2 visits during construction and last visit on completion of the dwelling. A Completion certificate will be provided to the Owner if the dwelling has been completed as per approved plans.



If the dwelling deviates from the approved plan, the owner or his Architect must submit as-built plans for approval.

Additional Architect scrutiny and Administration fees would be payable.

Please refer to the *Builders Code of Conduct* for the builder's deposit and fees prior to construction.

2.2 Approval

The approval or rejection of any proposed dwelling by the Developer or his representative is final and binding by agreement.

2.3 Power of Veto

Notwithstanding all aesthetic requirements, the Developer retains the authority to approve or reject any Architectural plans that they may consider appropriate or inappropriate for the St Helena Views Security Estate.

2.4 Contractors:

All contractors must be approved by the Home Owners Association before construction can commence. Contractors must be registered with the NHBRC. *Also refer to the Builders Code of Conduct.*

2.5 Construction:

All building work once commenced, shall be completed in as short and reasonable time as possible and shall be executed in a workman-like manner, within a maximum period of 24 months. All materials used, to be of good quality. Walls are to be constructed either of Clay or Cement bricks, timber frame construction with Nutec cladding (horizontal shiplap boards only). These are to be considered for the main dwelling. Concrete blocks are not permitted.

The site and the surrounding open land must be kept clear of rubbish at all times, to the satisfaction of the HOA. *Refer to Builders code of conduct.*

The following must be adhered to:

- All buildings, structures and walls are to be completed as per approved plans
- Any amendments on drawings after approval must be re-submitted to controlling Architect for approval as well as to the Local Authority.
 - **Scrutiny fees as well as Administration fees would be payable.**
- All paving, boundary walls, landscaping must be completed within the maximum period of 24 months.
- All site huts/toilets must be removed on completion of building period.
- Adjacent kerbs, pavements are to be reinstated to the original condition, the HOA has the right to repair these and deduct the costs from the Builders deposit. *Refer to builder's code of conduct.*
- All rubble to be removed regularly.



If any of the above conditions are not adhered to, the HOA has the Authority to cease building work until all conditions have been met. Any expenses incurred will be for the Owner's account.

2.6 National Building Regulations:

Should any provision in this Architect Design manual be regarded as contrary to the National Building Regulations, then the National Building Regulations shall prevail.



3. BUILDING RESTRICTIONS

3.1 Density:

Only one dwelling per erf would be permitted.

3.2 Height Restriction:

The Dwellings are limited to a height restriction of **8 meters** measured from the mean ground level (average point between lowest and highest point of property) up to the highest point of roof. (Refer to illustration) The chimney to be a minimum of 1m above the highest point of the roof. A height certificate by a registered land surveyor must be provided on submission of plans.

PLEASE NOT THIS WILL ONLY BE ALLOWED FOR WHEN MAJOR ROOF USE PITCH ROOF FORMS.

MONO-PITCH ROOF FORMS ARE LIMITED TO SINGLE STOREYS – REFER 4.2.2

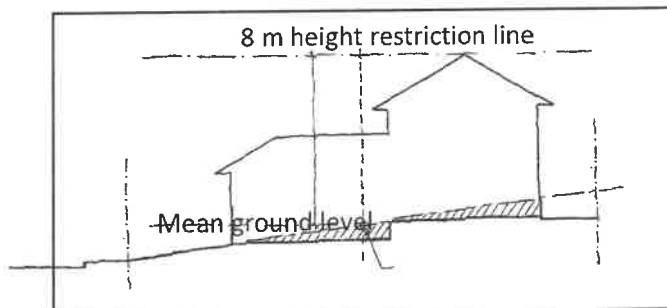

HEIGHT RESTRICTION PERMITTED

3.3 Coverage:

Maximum coverage of 50% is permitted. There is a minimum requirement of 100m² of habitable floor area. This excludes garages, stores etc. Each dwelling, in addition to the 100m² of habitable floor area, is to have at least a single garage.

3.4 Building lines:

The building lines for the residential erven must conform with the zoning scheme approved by the Local Authority.



Owners may apply for a waiver for the construction of the garages on a 0m side building line subject to the following conditions:

- Only one boundary may be utilized
- Garage not to be utilized as a balcony if constructed on 0m building line.
- Neighbour consent is to be provided
- Final approval by Local Authority

3.5 Garages and Covered Parking:

Pergolas and non-covered parking areas may be constructed on the erf side boundary line as approved by the architect, subject to the approval of the Local Authority. Any relaxation of building line would be subject to the approval of the Local Authority.

3.6 Siting of Buildings:

Owners are advised to liaise with their neighbours when planning their homes. The positioning of your building should not unreasonably affect the amenities of nearby properties. For example, servant's quarters, service yards and entertainment areas should be sensitively positioned, and your neighbour's privacy be respected.

3.7 Conditions on sloping sites:

Units designed for level sites cannot be used on sloping sites. It would be an inappropriate design and would require expensive site works and possibly unsightly retaining structures and embankments.

Large scale cut and fill will be seen as unsympathetic and will not be permitted. Cut and fill must be minimised as far as possible. (Refer to illustration)

The site is not to be reshaped in order to deal with the slopes.

The following measures will ensure that the visual impacts associated with building on steep slopes with gradient less than 1:8 will be minimised:

- Retaining structures are to be limited to 1,5m in height. If greater is required a second retaining structure must be at least 1m set-back from the previous one.
- The steps should be landscaped to minimise the overall impact.
- Slope planting to be introduced
- Select the correct planting material for the St. Helena coastal conditions
- The use of Terraforce blocks would also be considered for retaining and need to be indicated on the plans for approval. Terraforce blocks must be stepped in such a way that planting can be incorporated.



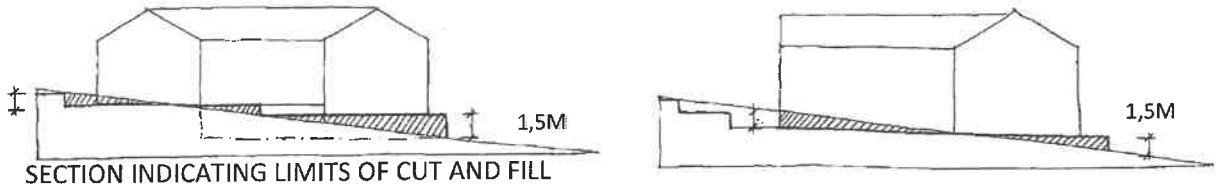

USE OF TIMBER STEPS AND INNOVATIVE TIMBER RETAINING STRUCTURES.

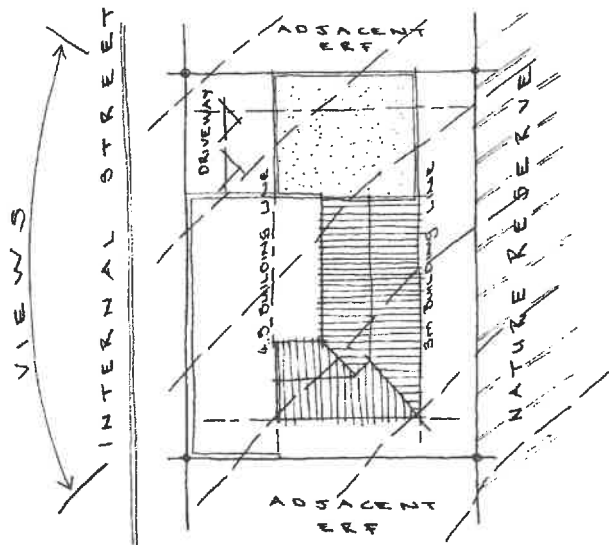
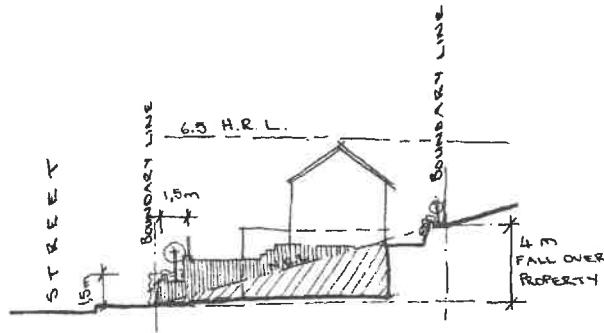

TYPICAL WORST-CASE SCENARIO



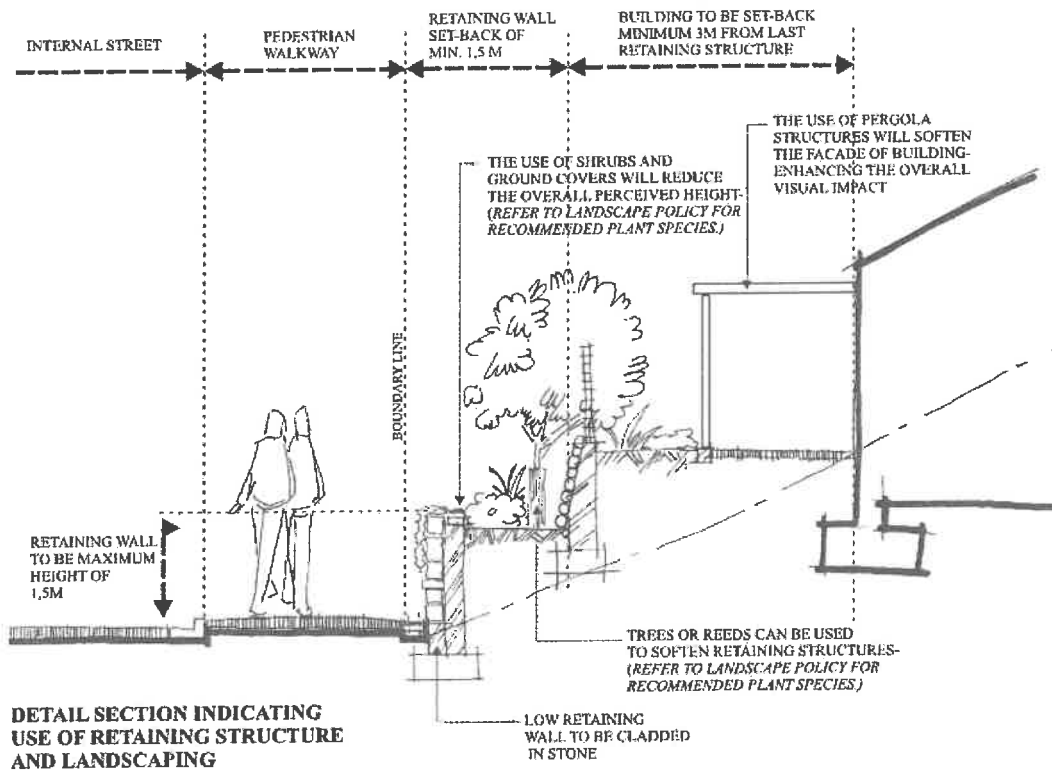

3.8 Landscape Guidelines:

The intention is to ensure that all planting material introduced to the design is indigenous vegetation typical of and suited to the local area. The use of traditional west coast trees in conjunction with indigenous species is recommended.

The following illustrations refer to typical retaining structures that may be used:

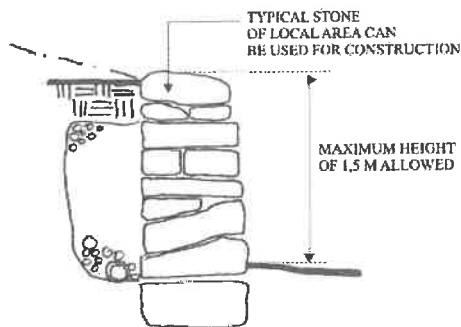

DRY STONE WALL

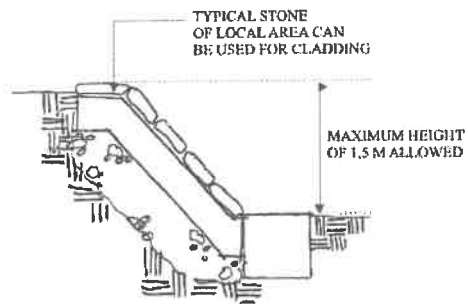

STONE BANK



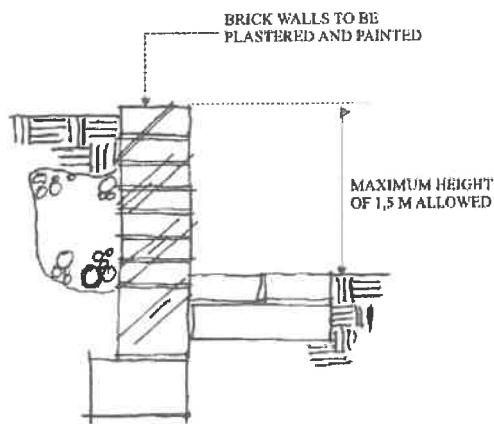

BRICK WALL

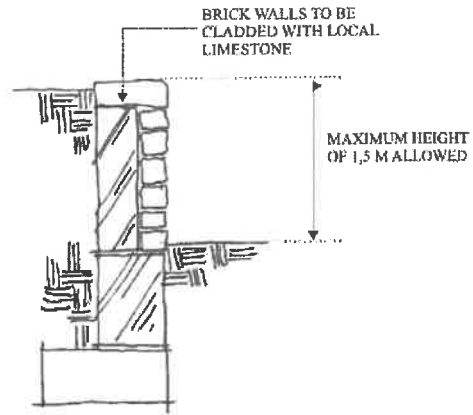

STONE/BRICK VENEER WALL

3.9 Driveways:

Driveway materials that are permitted is granite cobbles, exposed aggregate paving, traditional grey/charcoal paving. **Paving specifications and colour** to be provided on drawings for approval.

3.10 Garages:

Each property to have a minimum of one garage and is to be provided with carriageway crossing and complete driveway. An additional on-site parking is to be provided.

If the garage door faces onto street, doors must not be closer to the street front boundary than 4,5 meters.

A third garage is permitted if it is built separately from the double garage.

3.11 Outbuildings:

Outbuildings must be in the same style and finish as the house.

There are several ways of achieving continuity by linking facades of buildings which then define the street edge. A wall which serves as a linking element on the street façade may be of the same height and the wall plate of the building next to it.

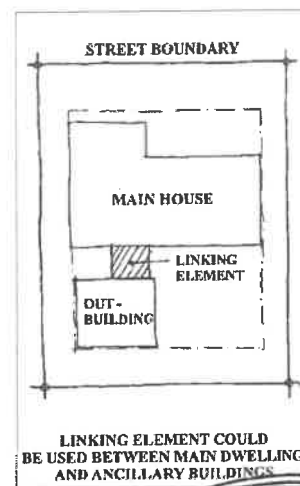

3.12 Ancillary Buildings:

No prefabricated stores, Wendy houses or temporary structures shall be erected, except during construction when a single site-hut/store may be permitted but must be removed on completion of the Dwelling.

3.13 Boundary walls:

Boundary walls need to be considered on sloping sites. No walling is obligatory. Boundary walls may be 2,1m in height taken from ground level between houses and back yard areas from the road. However, should the property adjoining on lower contour be excavated to lower basement level, then 2,1m height may be exceeded.

Boundary walls on street to be maximum 1,5m in height and side boundaries within 5 meters from the street boundary line also restricted to 1,5 meters in height.

3.14 Yard walls:

A service yard is an area adjoining a structure, and housing certain service items. The outer wall of the service yard may be incorporated as part of a boundary wall.

Service yard walls must be 2,1m high and effectively screen items in service yard from the street.

3.15 Energy Efficiency:

As the owner of a new building, you will be obliged to get your Architect to design at least the minimum legal energy efficiency into your plans as per the SAN 10400-XA. This may mean expensive glass/windows and insulation to the roof, coupled with energy efficient hot water heating, lighting and temperature controlling equipment.

Energy efficiency calculations would be required when submitting drawings to the local Authority for approval. The local Authority may also require certification from the professional indicating that they have done a registered course for Energy efficiency of buildings.



4. APPROVED ARCHITECTURAL ELEMENTS AND PROHIBITED MATERIALS

4.1 Roofs:

The following roof finishes are permitted:

- Charcoal, White and Lime White colour permitted
- Metal roof finish to approved profile
- Aluzinc Colour bond ultra roof sheeting or similar approved
Colours: Dark Dolphin, Charcoal, White and Lime White
- Victorian profile roof sheeting, Colours: Dark Dolphin, Charcoal, White and Lime
- Waterproofed concrete roof slabs, visible roofs to be finished with gravel stone chips (grey or brown)
Only 20% of roof dwelling may be flat roofs.
- Natural slate roofs are permitted – only Grey and Black colours permitted
- Lafarge concrete roof tiles or similar approved, colours Grey and Black



The following roof finish will not be permitted:

- No **galvanised roof** sheeting will be permitted
- No Black roof sheeting will be permitted
- No Green, Red, Blue or multi-colour roofs would be
- No thatch roofing permitted.
- No wooden shingles
- No reflective sheeting
- No in-situ concrete thatch look

Architect to specify roof finish as well as colour on drawings.

4.2 The following roof forms are permitted in the following phases of the estate (REFER TO ATTACHED MAP INDICATING THE PHASES):

4.2.1 Phase 1A and Phase 1B

Major roof forms:

- Major roofs shall be double pitched and coincide with major plan elements
- The use of simple pitched roofs with truss spans not exceeding 7m.
- Attic spaces may be used
- Pitches are to be symmetrical about their ridges and must have a slope of minimum 30 degrees and maximum 45 degrees.

Lean-to/Verandah roofs



- The area of minor roofs, excluding outbuildings, should not exceed 30% of the major roof.
- Lean-to and verandah roofs are to have a pitch of 5 to 10 degrees.
- Lean-to roofs on higher sloped properties would act as scaling elements.

Concrete Roofs

- Flat roofs with parapets may be necessary to connect a series of major plan forms and will be defined as an additional minor roof form. Should not exceed 30%.

4.2.2 Phase 2 and Phase 3 (The Coves and Kapteinskloof)
(REFER TO ATTACHED MAP INDICATING THE PHASES)

Major roof forms:

The following roof forms may be used only in Phase 2 and 3:

Roof option A: (PITCH ROOF FORM) (HEIGHT RESTRICTION OF 8M)

- Major roofs shall be double pitched and coincide with major plan elements
- The use of simple pitched roofs with truss spans not exceeding 7m.
- Attic spaces may be used
- Pitches are to be symmetrical about their ridges and must have a slope of minimum 30 degrees and maximum 45 degrees.

Lean-to/Verandah roofs

- The area of minor roofs, excluding outbuildings, should not exceed 30% of the major roof.
- Lean-to and verandah roofs are to have a pitch of 5 to 10 degrees.
- Lean-to roofs on higher sloped properties would act as scaling elements.

Concrete Roofs

- Flat roofs with parapets may be necessary to connect a series of major plan forms and will be defined as an additional minor roof form. Should not exceed 30%.

Roof option A: (MONO-PITCH ROOF FORM) (SINGLE STOREY ONLY)

Roof Option B: (MONO-PITCH ROOF FORM) – restricted to single storey structures only, no double-storey mono-pitch or double-storey flat roof structures permitted.

- Major roofs may be mono-pitch and coincide with major plan elements
- Truss spans not exceeding 7m.
- Mono-roofs must have a slope of minimum 10 degrees and maximum 15 degrees.

Lean-to/Verandah roofs

- Lean-to and verandah roofs are to have a pitch of 5 to 10 degrees.



- Lean-to roofs on higher sloped properties would act as scaling elements.

Concrete Roofs

- Flat roofs with parapets may be necessary to connect a series of major plan forms and will be defined as an additional minor roof form. Should not exceed 30%.

Please note that a combination of mono pitch or pitch roofs may be used in Phase 2 and Phase 3.

Rainwater goods that can be used would be seamless aluminium gutters, Ogee profile gutters and PVC gutters and downpipes. Gutters to match fascia colour or the roof colour and must be consistent on one property. Downpipes must match walls or gutters in colour and must be consistent on one property.

Note: Gables should be simple in design, no elaborate mouldings will be permitted.

No exposed plumbing above gutter line.

4.3 Walls:

The following wall finishes are permitted:

- Everite nutec planks (shiplap) or similar approved. Must be painted to approved colour. **No nutec flat sheets for wall cladding would be permitted.**
- Walls must have clear, plain smooth plaster surface [Slightly rough and sponge finished, to create a “older West coast feeling”]
- Pigmented plaster to approved colour
- Dry pack natural stone walling/cladding – Local stone White to be used
- Cladding encouraged on feature walls, for example chimneys etc.
- Plinths to be same colour as main dwelling [Or can be left in concrete finish]
- Wall colours as per approved list below – any other colour to be specified and approved by controlling Architect.

▪ Plascon White range for main walls :	Silver bird	E27-1
	Evening mist	WHT 08
	Coast Cream	WHT 06
	Plaster	E16-2
	Sand Crystal	WHT 09
	Scalloped potato	C15-2

Dulux Weatherguard: Cape Fog

▪ Plascon range for Accent walls:	Stone wash	Y2-D2-2
	Veldrift	Y2-D2-3
	Country mushroom	Y1-D2-3
	Artist’s canvas	Y2-E2-3
	Evasive white	Y4-E2-3

- Colours to be specified on plans



- Please note that the colours used must complement each other.
- Accent colours may be used to accentuate elements such as windows, doors, balustrades, gates doors, exposed timber etc.

The following wall finish will **not** be permitted:

- o No coloured wall coatings and textured such as Marmoran and Earthcote cement, based paints and textured coatings.

4.4 Plumbing pipes:

All plumbing pipes, particularly from upper storeys, must be concealed within the walls. Vent stacks should be avoided. Use the new vent breather valve or similar approved. Visible branches to a VBV may not exceed 300mm.

4.5 Fenestration – Windows and Shutters:

The following materials are permitted:

- o Anodised or epoxy coated aluminium to approved colour.
- o Timber with stain or varnished finish to approved colour
- o Painted timber to approved colour.
- o PVC to approved colour.

The following colours are permitted:

- White, Charcoal, anodised aluminium (Colour of windows must be provided on the drawings)
- Window and glass pane proportions should be either square or vertical proportions. It is important that the vertical emphasis is maintained.
 - o No reflective glass would be permitted
 - o All external shutters must be able to cover the entire window when closed. Shutters could also be decorative.
 - o Burglar bars should be fitted to the internal face of doors and windows and should align with the mullions and transoms. No external burglar bars are permitted.

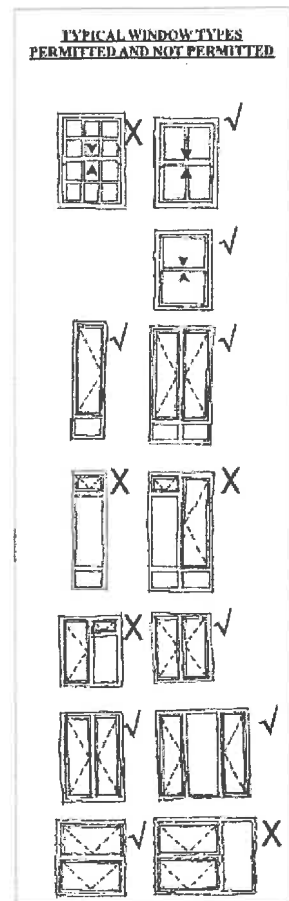

- Large glazed windows and doors would be permitted if considered as an integral part of expressing the style. Large scale doors and windows would need some shading device, i.e. pergola, or roof covering.
- Gable windows for loft rooms may be used.



Clerestory windows:

- Clerestory windows will be defined as the windows found in the vertical section of loft room walls.
- All clerestory windows must be centered on openings below and evenly spaced.
- Windows are to be centered between the finished floor level of the loft room and the wall plate height.

No Dormer windows will be permitted.

- Rooflights may be used, provided that they are of similar size, height and alignment of each roof. These must be indicated on the drawings.

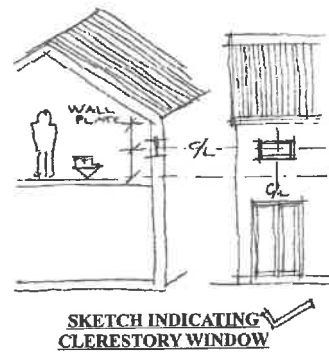

4.6 Fenestration – Doors and Gates:

The following materials are permitted:

- Anodised or epoxy coated aluminium to approved colour.
- Timber with stain or varnished finish to approved colour
- Painted timber to approved colour.
- PVC to approved colour.

The following colours are permitted:

- White, Charcoal, anodised aluminium (Colour of windows must be provided on the drawings)

No decorative surrounds are permitted.
No steel doors are permitted.

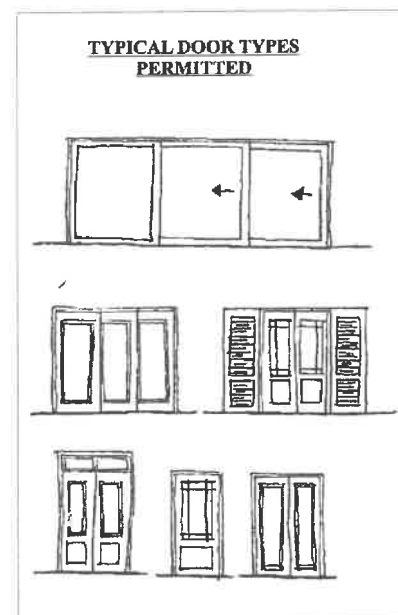

- Garage doors can either be of single or double width and manufactured of either timber (natural varnished or painted) or epoxy/powder coated aluminium of glass fibre to match window and door colour.
- Gates shall either be of solid timber, properly framed and braced with horizontal, vertical or diagonal planking, or of galvanised painted steel of simple design. Aluminium gates will also be permitted, however, they must be the same colour as the main dwelling.

4.7 Chimneys:

- o Chimneys must be simple in design. [“Abba” Fireplace with chimney, in the typical West Coast style are encouraged in Cove and Kapteins kloof]

4.8 Yard:

- o Kitchen yards should be at least 1,8m in height and indicated on plan. All services such as washing lines, gas bottles, dustbins should be situated in the yard area and must not be visible from the road. [2.1 meters, as stated previously]
- o Caravans should have a dedicated parking area and screened with gates from the road.

4.9 Balconies and Terrace:

- o Balconies and terraces should have clean lines with plain railings. Glass balustrades are permitted.
- o Heavy brick or concrete support columns are not permitted.

4.10 Shade provision:

- o Traditional style verandas or pergolas are preferred. Liaise with controlling Architect.
- o No Fabric Awnings will be allowed.
- o No shade netting will be permitted.
- o Aluminium awnings may be used but must be enclosed by parapet walls.
- o Pergolas should be planed timber, natural or painted, or treated round poles.
- o Columns/piers may also be plastered masonry. Colour to be approved.

4.11 Aerial and solar panels:

- o Satellite dishes must be unobstructive.
- o No overhead wires are permitted.
- o Solar panels should be flush with roof and all pipes must be concealed. These must be indicated on the plans and design as an integral part from beginning.



4.12 Lighting and signage:

- Lighting should be kept to a minimum (avoid light spillage).
- Low level lighting is encouraged.
- No spotlighting is permitted.
- Street numbers should be of a simple design. Must be appropriate to the design of the house.

5. DEFINITIONS

LOCAL AUTHORITY:	The Saldanha bay municipality
DEVELOPER:	West coast Miracles (Pty)Ltd or Appointed representative
CLIENT:	Owner of an erf within the St Helena Views Development
CONTROLLING ARCHITECT:	JHS Architects Jaco Serfontein
HOME OWNERS ASSOCIATION:	Association formed by the property owners of St Helena Views Security Estate.

6. OCCUPATION

All owners to note that it is their responsibility to notify the Controlling Architect when final completion has been reached for the final inspection.

All owners must provide the Controlling Architect or HOA with a copy of the final Occupation certificate issued by the Local Municipality.



